



Cambridge International Examinations
Cambridge Primary Checkpoint

CANDIDATE
NAME

--

CENTRE
NUMBER

--	--	--	--	--

CANDIDATE
NUMBER

--	--	--	--

MATHEMATICS

0845/01

Paper 1

October 2015

45 minutes

Candidates answer on the Question Paper.

Additional Materials:

Pen
Pencil
Ruler

Protractor
Tracing paper (optional)

READ THESE INSTRUCTIONS FIRST

Write your Centre number, candidate number and name in the spaces at the top of this page.
Write in dark blue or black pen.

DO **NOT** WRITE IN ANY BARCODES.

Answer **all** questions.

Calculators are **not** allowed.

The number of marks is given in brackets [] at the end of each question or part question.
You should show all your working in the booklet.
The total number of marks for this paper is 40.

This document consists of **14** printed pages and **2** blank pages.



1 Write the missing numbers.

(a) $67 + \boxed{} = 100$

[1]

(b) $650 + \boxed{} = 1000$

[1]

2 Double 76

..... [1]

3 Complete the calculations.

(a) $376 \times 10 = \boxed{}$

[1]

(b) $\boxed{} \div 10 = 48$

[1]

4 This is part of a calendar for May.

S	M	T	W	T	F	S
		1	2	3	4	5
6						

Graham's birthday is on 26th May.

Which day of the week is his birthday?

..... [1]

5 Shade $\frac{1}{5}$ of this diagram.

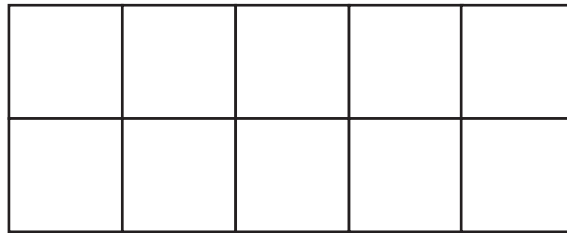

[1]

6 (a) Draw a rectangle 5 cm long and 2 cm wide by joining dots on the grid.

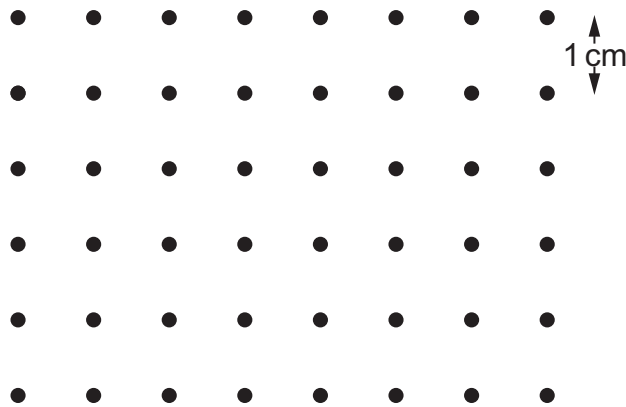

[1]

(b) Find the perimeter of the rectangle.

..... cm [1]

7 A piece of string 3 m 24 cm long is cut into two equal lengths.

How long is each piece?
Give your answer in metres.

..... m [1]

8 Abdul records the shoe colour of every person in his class. They are:

Blue	Black	Brown	Brown	Black	Brown	White	Black	Blue
White	Black	Black	Blue	Brown	Black	Blue	Blue	Black

(a) Complete the table to show the data.

Shoe colour	Tally	Frequency
Black		7
Blue		
Brown		
White		2

[1]

(b) Which shoe colour is the mode?

..... [1]

9 Write in the missing number.

$$\boxed{} = 70 \times 3$$

[1]

10 (a) One block of butter has a mass of 250 grams.

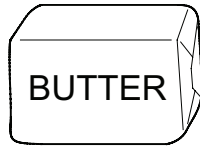

How many blocks of butter will Ali need to buy so that he has 1 kg of butter?

..... blocks [1]

(b) Laura has one metre of ribbon.
She cuts off 35 cm.

How much ribbon does she have left?

..... cm [1]

11 Complete each of the multiplications.

Use **different** whole numbers for each multiplication.

The first one has been done for you.

$$1 \quad \times \quad 24 \quad = \quad 24$$

$$\dots \times \dots = 24$$

$$\dots \times \dots = 24$$

$$\dots \times \dots = 24$$

[1]

12 (a) Round 2648 to the nearest hundred.

..... [1]

(b) Round 3568 to the nearest ten.

..... [1]

13 Complete this calculation.

$$4035 - \square = 54$$

[1]

14 Imagine a number is written on each of these shapes.

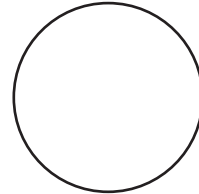
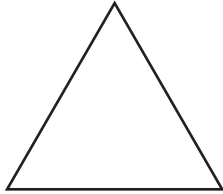

The number on the rectangle is 3 more than the number on the triangle.
The number on the circle is 3 more than the number on the rectangle.
The number on the circle is 3

What number is on the triangle?

..... [1]

15 Here are the results of a maths test.

Name	Score
Lia	155
Ben	94
Aisha	136
Murun	100
Javid	118

The results are shown on the bar chart.

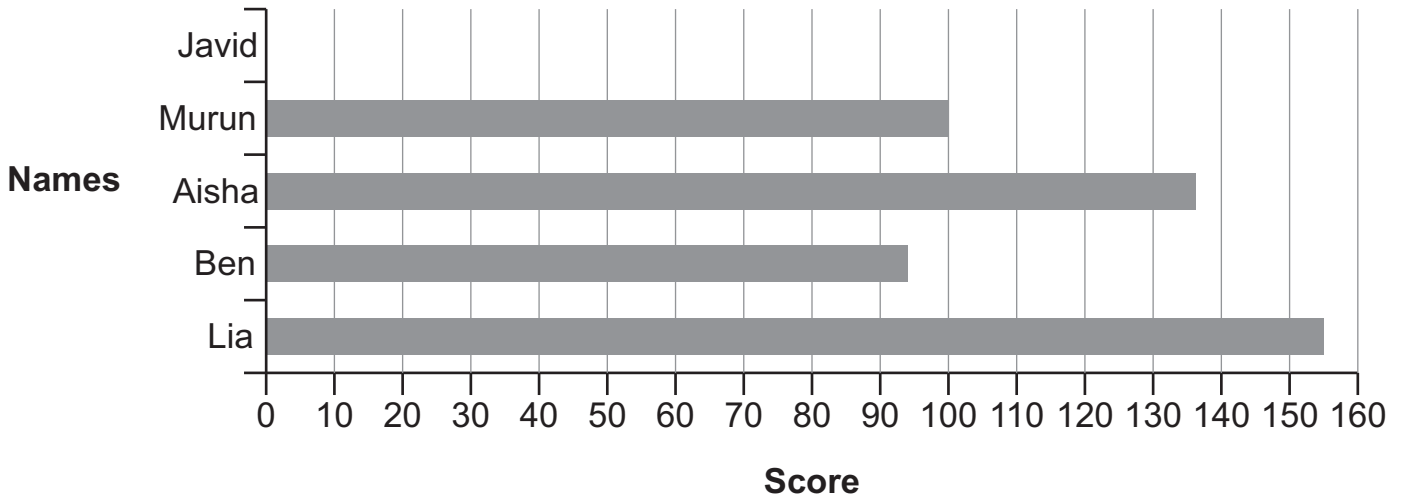

(a) Complete the bar chart to show Javid's score. [1]

(b) What is the median score?

..... [1]

16 (a) What is the size of one of the angles in an equilateral triangle?

..... ° [1]

(b) What is the name of a triangle with only two equal sides?

..... [1]

17 Calculate $3474 - 1997$

..... [1]

18 Here is a number fact.

$24 \times 16 = 384$

Use this fact to complete these calculations.

(a) $2.4 \times 16 =$ [1]

(b) $24 \times 32 =$

[1]

19 Calculate

(a) 30×600

..... [1]

(b) 0.3×6

..... [1]

20 (a) What is the value of the digit 2 in the number 4.02?

Draw a ring around the correct answer.

2 hundreds

2 tens

2 units

2 tenths

2 hundredths

[1]

(b) What is the value of the digit 5 in the number 125 319?

..... [1]

21 Mary has 4 white straws and 4 grey straws.

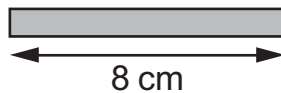
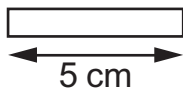

Not drawn to scale

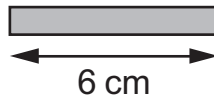
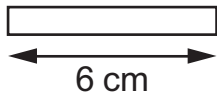
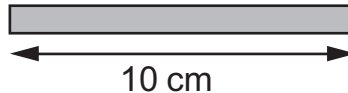
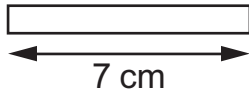
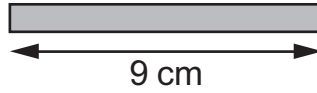
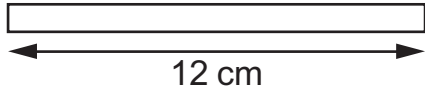

Mary uses 1 white straw and 1 grey straw to make a **total** length of 15 centimetres.

Find **all** the ways Mary could do this.

[1]

22 Here are four cards.

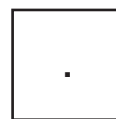
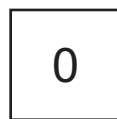

Use each card once to make the largest number that is less than 10

--	--	--	--

[1]

23 Here is a spinner with eight equal sections.

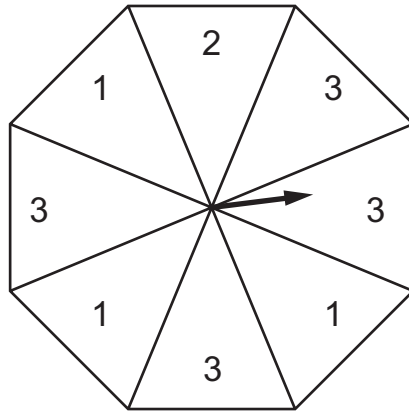

(a) Which number has an even chance of coming up?

..... [1]

(b) John says

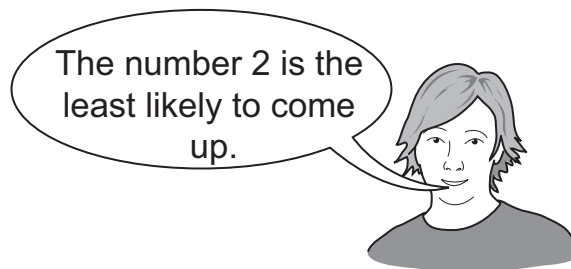

Explain why he is correct.

.....
 [1]

24 The temperature in Moscow in February is -13°C .
 The temperature in London is 2°C .

What is the difference in the temperature between the two cities?

..... $^{\circ}\text{C}$ [1]

25 Jodi makes a bracelet using beads.

She uses 3 large beads for every 2 small beads.



She uses 35 beads altogether.

How many small beads does she use?

..... beads [2]

26 Ami says

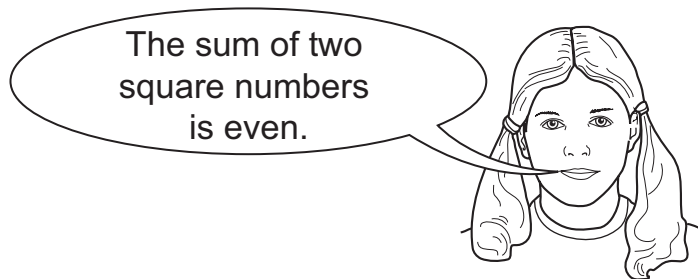

Give an example to show that Ami **could** be right.

..... [1]

27 Rotate the triangle 90° anticlockwise about point B .

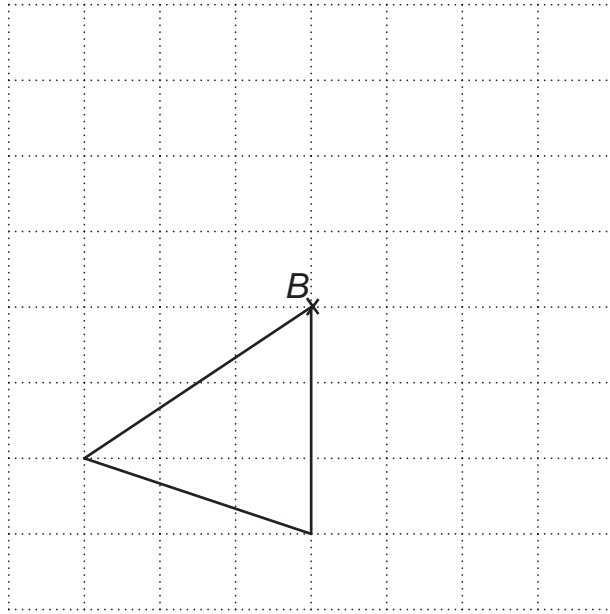

[1]

BLANK PAGE

Permission to reproduce items where third-party owned material protected by copyright is included has been sought and cleared where possible. Every reasonable effort has been made by the publisher (UCLES) to trace copyright holders, but if any items requiring clearance have unwittingly been included, the publisher will be pleased to make amends at the earliest possible opportunity.

Cambridge International Examinations is part of the Cambridge Assessment Group. Cambridge Assessment is the brand name of University of Cambridge Local Examinations Syndicate (UCLES), which is itself a department of the University of Cambridge.