



UNIVERSITY OF CAMBRIDGE INTERNATIONAL EXAMINATIONS
Cambridge Primary Checkpoint

CANDIDATE
NAME

CENTRE
NUMBER

--	--	--	--	--

CANDIDATE
NUMBER

--	--	--	--



MATHEMATICS

0845/01

Paper 1

April 2013

45 minutes

Candidates answer on the Question Paper.

Additional Materials:

Pen
Pencil
Ruler

Protractor

READ THESE INSTRUCTIONS FIRST

Write your Centre number, candidate number and name in the spaces at the top of this page.

Write in dark blue or black pen.

DO NOT WRITE IN ANY BARCODES.

Answer **all** questions.

Calculators are **not** allowed.

The number of marks is given in brackets [] at the end of each question or part question.

You should show all your working in the booklet.

The total number of marks for this paper is 40.

For Examiner's Use

1	
2	
3	
4	
5	
6	
7	
8	
9	
10	
11	
12	
13	
14	
15	
16	
Total	

This document consists of **16** printed pages.





1 Calculate

$$423 - 298 =$$

..... [1]

2 Fatima has 72 oranges.

Four oranges are needed to make a glass of freshly squeezed orange juice.

How many glasses of orange juice can she make?

..... glasses [1]



3 (a) Shade $\frac{2}{5}$ of the shape.

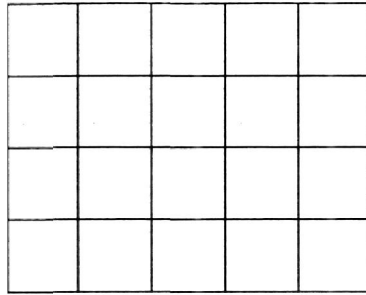

[1]

(b) What fraction of the shape below is shaded?

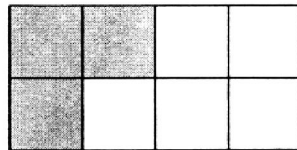

..... [1]





4 The Venn diagram shows information about the children in a Grade 6 class.

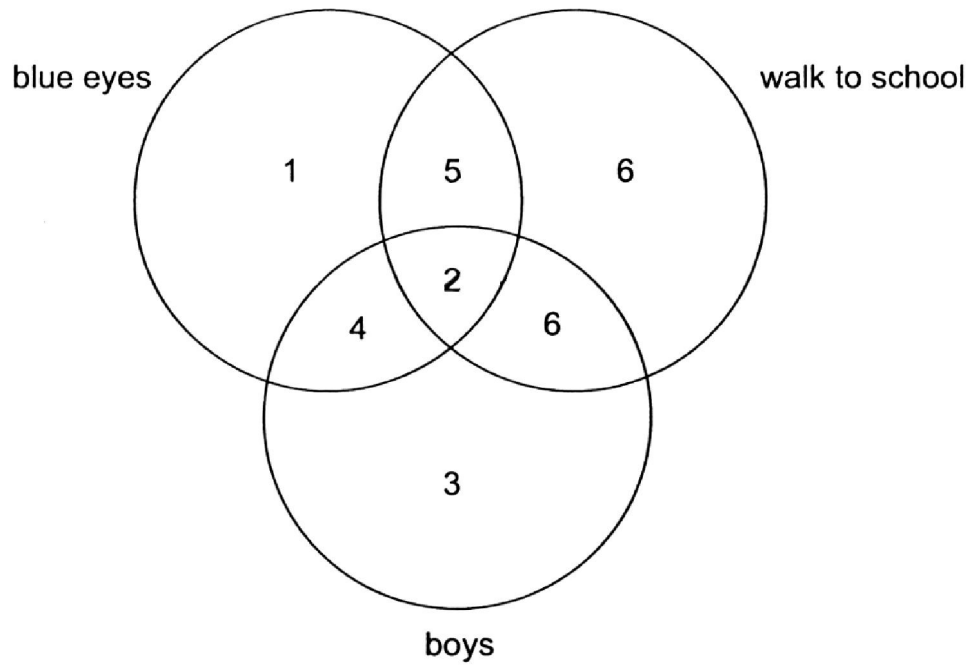

How many children in this class walk to school?

..... children [1]





5 Here is a number fact.

$$14 \times 37 = 518$$

Use this fact to decide whether these calculations are true or false.

$518 \div 37 = 14$ True False

$37 \div 518 = 14$ True False

[1]

6 Write all the missing numbers in this multiplication grid.

×			
	42	48	54
	49		63
8		64	72

[2]





7 A box contains 30 chocolates.



How many chocolates are in 6 of these boxes?

..... chocolates [1]

8 Draw a line 68 mm long.

You must use a ruler.



[1]

9 Fatima is thinking of a number.

She says

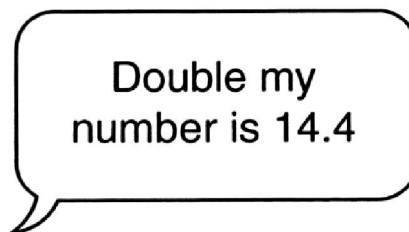

What number is Fatima thinking of?

..... [1]



10 A, B and C are three vertices of a square.

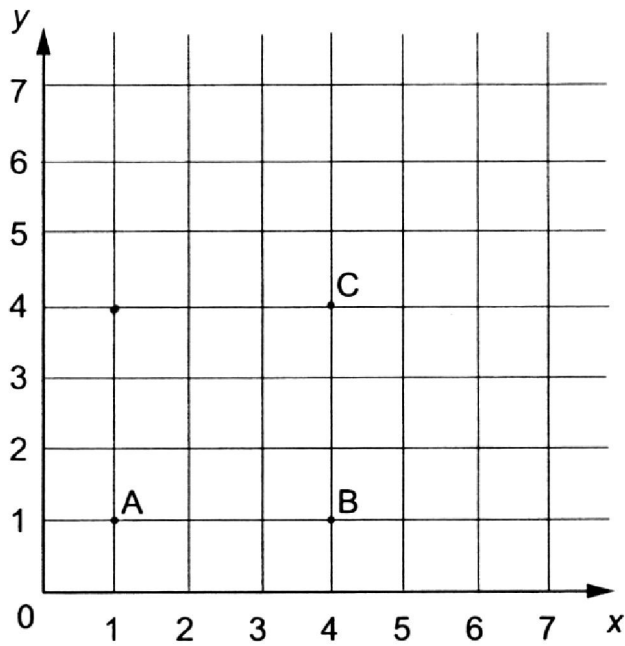

What are the co-ordinates of the fourth vertex?

(..... ,) [1]

11 Shade 5 more squares so that this shape has 2 lines of symmetry.

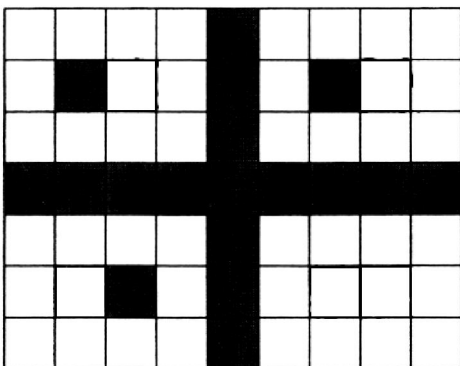

[1]





12 Write these fractions in their simplest form.

$$\frac{6}{12} = \dots\dots\dots$$

$$\frac{12}{15} = \dots\dots\dots \quad [1]$$

13 Write each number in its correct box to show its position on the number line.

9482 9842

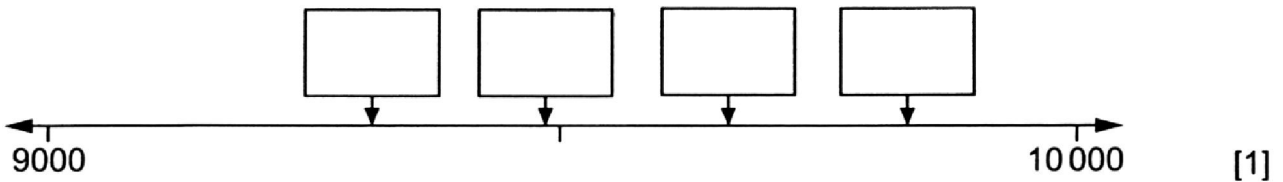

14 Here are three mixed numbers.

$$5 \frac{1}{4}$$

$$7 \frac{1}{2}$$

$$3 \frac{3}{4}$$

Write each number in its correct box on the number line. You will not need all of the boxes.

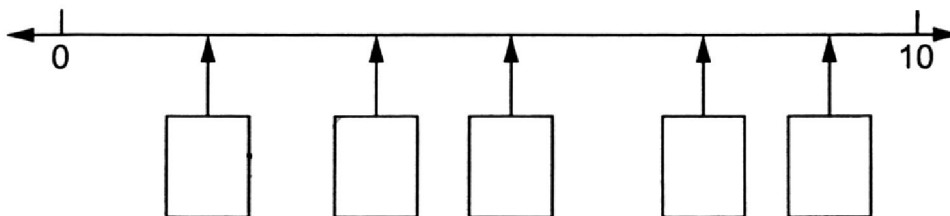

[2]



- 15 Here is a 1 cm^2 grid.
Draw a rectangle with a perimeter of 12 cm.

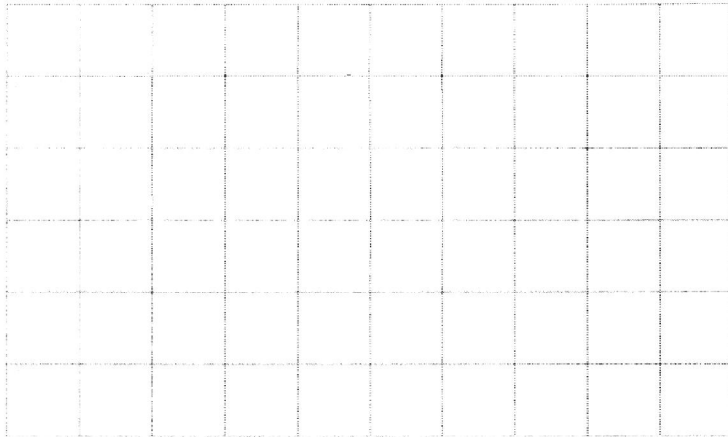

[1]

- 16 What is the missing number?

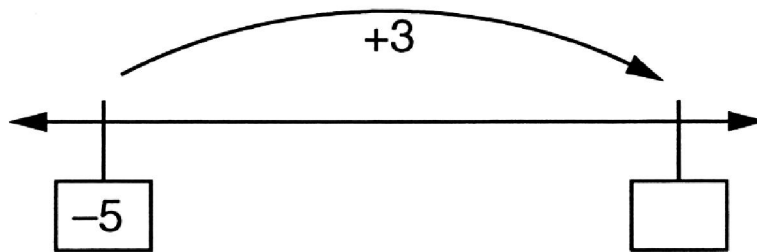

[1]





17 A sequence starts at 300 and 40 is subtracted each time.

300 260 220 180.....

The sequence continues in the same way.

What is the first number in the sequence which is less than zero?

..... [1]

18 Draw a ring around **all** the numbers that are factors of 42

1 2 3 4 5 6 7

[1]

19 Write the missing numbers in each box.

(a) $0.4 + \boxed{} = 1$

[1]

(b) $3.3 + \boxed{} = 10$

[1]

20 Draw a ring around **all** the numbers which are multiples of 25

250 730 675 380 55

[1]



21 (a) Calculate.

$$400 \times 70$$

..... [1]

(b) Here is a number fact.

$$18 \times 5 \times 6 = 540$$

Use this to work out

$$18 \times 5 \times 12$$

..... [1]

22 Write the missing number.

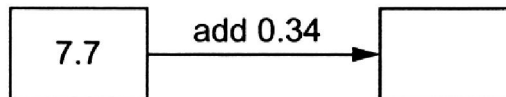

[1]





23 Here is a clock face showing a digital time.

23:23

Draw a ring around the time that is the same as that shown on the clock.

11:23 am

3:23 pm

11:23 pm

2:23 pm

3:23 am

[1]

24 John records how many points each of his friends get on sports day. Here are the results.

15, 12, 8, 16, 11, 12, 9,
12, 15, 14, 4, 9, 12, 18,

(a) What is the mode of the points scored?

..... [1]

(b) Complete the frequency table.

	Tally	Frequency
0 – 4		
5 – 9		
10 – 14		
15 – 19		

[1]



- 25 At midday the temperature in Moscow was 7°C .
At midnight it was -3°C .

By how many degrees did the temperature fall?

..... $^{\circ}\text{C}$ [1]

- 26 (a) Draw a ring around the two fractions which are equivalent.

$$\frac{3}{5}$$

$$\frac{6}{12}$$

$$\frac{10}{24}$$

$$\frac{15}{25}$$

$$\frac{7}{21}$$

[1]

- (b) Work out $\frac{2}{3}$ of 42

..... [1]





27 (a) Here are the heights of some children.

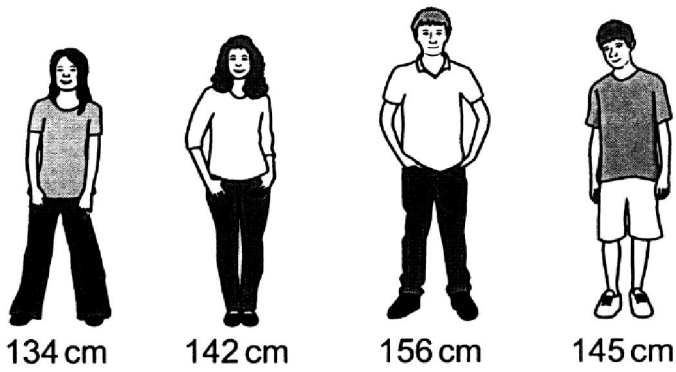

Calculate the range of their heights.

..... cm [1]

(b) The range of the heights of three adults is 17cm.

Write down possible heights of the shortest and tallest adults.

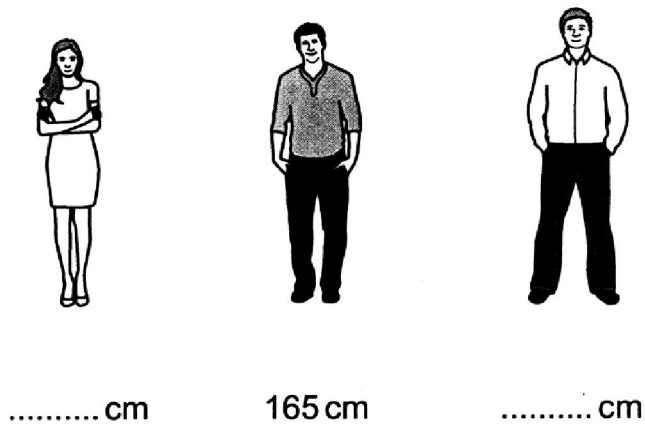

[1]



- 28 (a) Write three **different** whole numbers in the boxes to make the multiplication correct.

The numbers must be greater than 1.

$$\boxed{} \times \boxed{} \times \boxed{} = 60 \quad [1]$$

- (b) Write whole numbers in the boxes to make this division correct.

The numbers must be greater than 1.

$$\boxed{} \div \boxed{} = 60 \quad [1]$$

- 29 Write in the missing digits to make this calculation correct.

$$\begin{array}{r} \boxed{} \ 7 \ \boxed{} \\ \ 6 \ x \\ \hline 1 \ 0 \ 3 \ 2 \end{array}$$

[1]





30 Here is a compound shape made from two rectangles.

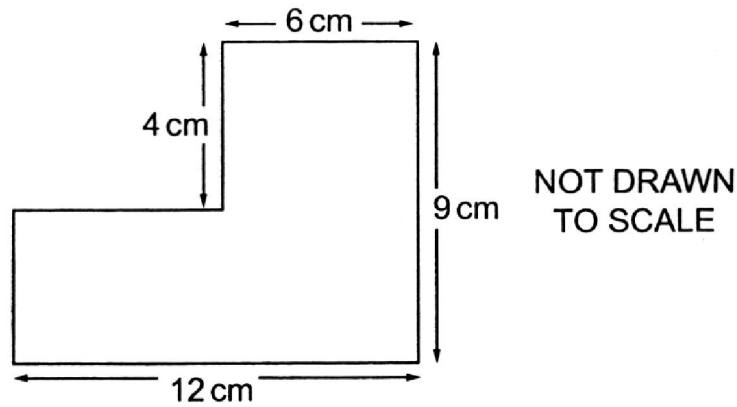

(a) Calculate the perimeter of the shape.

..... cm [1]

(b) Calculate the area of the shape.

..... cm² [1]

Permission to reproduce items where third-party owned material protected by copyright is included has been sought and cleared where possible. Every reasonable effort has been made by the publisher (UCLES) to trace copyright holders, but if any items requiring clearance have unwittingly been included, the publisher will be pleased to make amends at the earliest possible opportunity.

University of Cambridge International Examinations is part of the Cambridge Assessment Group. Cambridge Assessment is the brand name of University of Cambridge Local Examinations Syndicate (UCLES), which is itself a department of the University of Cambridge.